

WPLED52 INSTALLATION INSTRUCTIONS



Thank you for buying RAB lighting fixtures. Our goal is to design the best quality products to get the job done right. We'd like to hear your comments. Call the Marketing Department at 888-RAB-1000 or email: marketing@rabweb.com



WPLED52
Standard (15 Deg)



WPLED52
Cutoff (7.5 Deg)



WPLED52
Full Cutoff (0 Deg)

IMPORTANT

READ CAREFULLY BEFORE INSTALLING FIXTURE. RETAIN THESE INSTRUCTIONS FOR FUTURE REFERENCE.

RAB fixtures must be wired in accordance with the National Electrical Code and all applicable local codes. Proper grounding is required for safety. THIS PRODUCT MUST BE INSTALLED IN ACCORDANCE WITH THE APPLICABLE INSTALLATION CODE BY A PERSON FAMILIAR WITH THE CONSTRUCTION AND OPERATION OF THE PRODUCT AND THE HAZARDS INVOLVED.

WARNING: Make certain power is OFF before installing or maintaining fixture. No user serviceable parts inside.

MOUNTING TO A WALL

1. Orient box so that "TOP" is on top.
2. Secure **Wall Mounting Box** to a sturdy wall. Use appropriate mounting hardware such as lag bolts and anchors with washers suitable for the mounting surface.
3. Feed supply wires through **Wall Mounting Box**. Check that **Gasket** is fully sealed.
4. Bring fixture up to the **Wall Mounting Box** and slide the stainless steel **Tether** from the fixture into the **Key Hole Slot** for hands free wiring.
5. Wire the fixture using suitable wire connectors.
6. Place wired fixture over the **Wall Mounting Box** and tighten the **Top Screws**. Now tighten the **Lower Screws**.
7. Tighten **Close Up Plugs** and apply weatherproof silicone sealant to all unused conduit entry points. Also use sealant between the wall and **Wall Mount Box**.

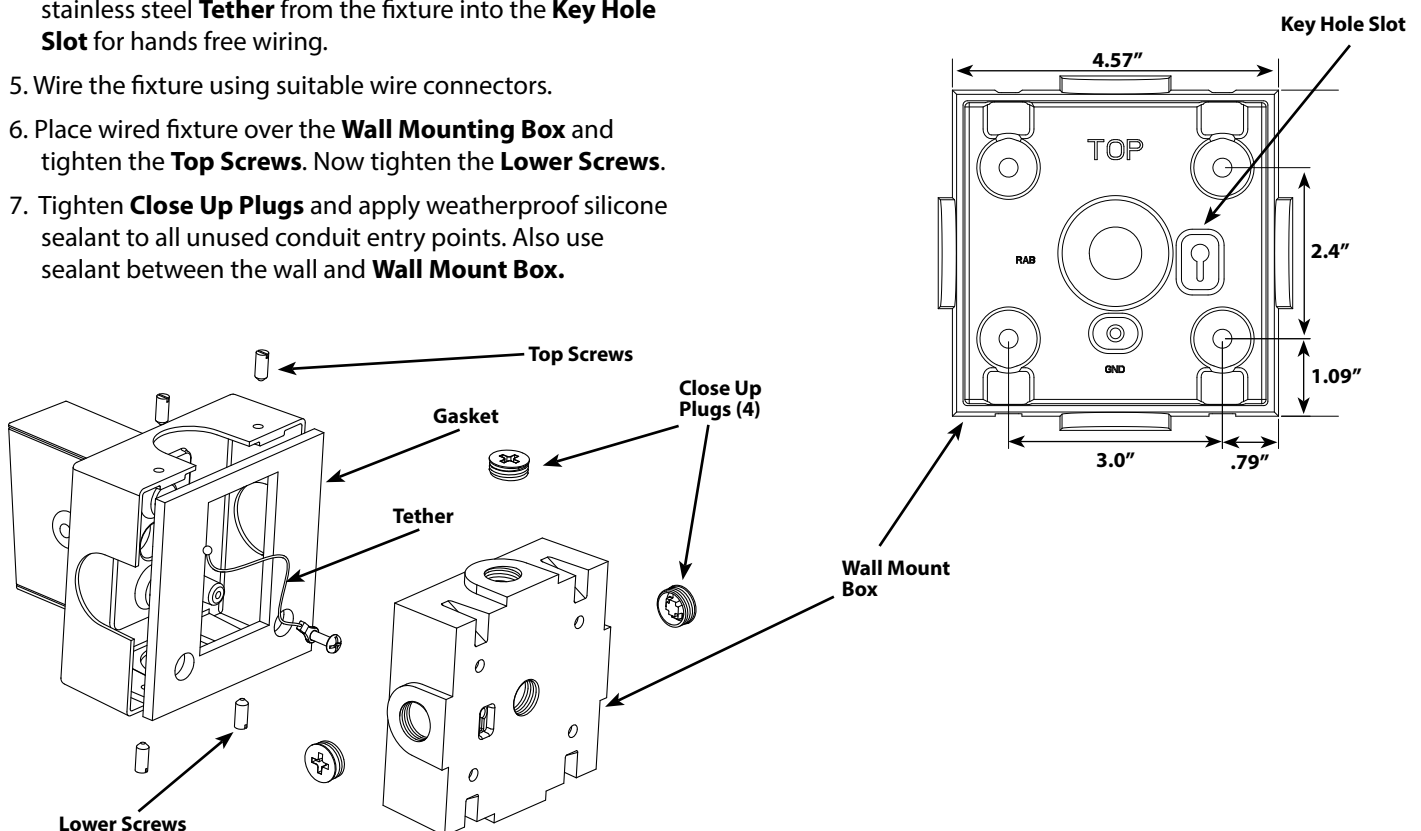
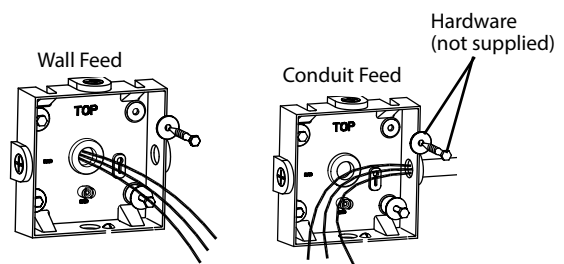

WPLED52 INSTALLATION INSTRUCTIONS

Thank you for buying RAB lighting fixtures. Our goal is to design the best quality products to get the job done right. We'd like to hear your comments. Call the Marketing Department at 888-RAB-1000 or email: marketing@rabweb.com

WIRING

Universal voltage driver permits operation at 120V to 277VAC, 50 or 60 Hz except fixtures factory ordered with a 120V swivel photocell (/PCS) or 277V swivel photocell (/PCS2)

1. Connect the BLACK fixture lead to the (+) LINE supply lead.
2. Connect the WHITE fixture lead to the (-) COMMON supply lead.
3. Connect the bare copper Ground wire from fixture to supply ground.

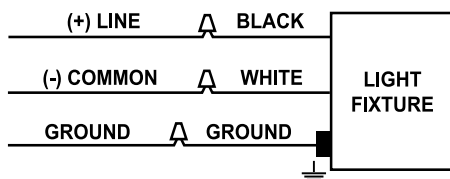

CLEANING & MAINTENANCE

CAUTION: Be sure fixture temperature is cool enough to touch. Do not clean or maintain while fixture is energized.

1. Clean glass lens with non-abrasive glass cleaning solution.
2. Do not open the fixture to clean the LED. Do not touch the LED.

PHOTOCELL INSTALLATION

Photocell may be installed in the field. Apply weatherproof silicone sealant to all plugs and unused conduit entries.

1. Remove close up plug on top of the wall mounting box.
2. Install photocell and wire as per diagram.
3. Use photocell rated for your supply voltage.

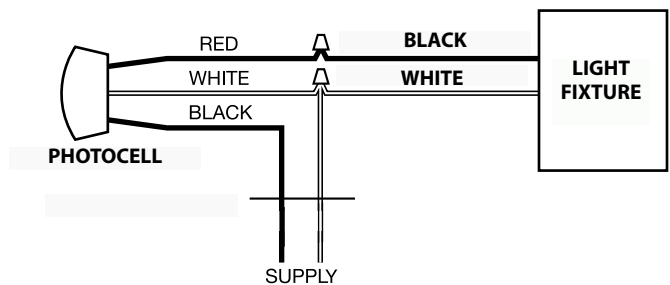

TROUBLESHOOTING

1. Check that the line voltage at the fixture is correct. Refer to wiring directions.
2. Is the fixture is grounded properly?
3. Is the photocell, if used, functioning properly?

Note: These instructions do not cover all details or variations in equipment nor do they provide for every possible situation during installation, operation or maintenance.

WPLED52 INSTALLATION INSTRUCTIONS



Thank you for buying RAB lighting fixtures. Our goal is to design the best quality products to get the job done right. We'd like to hear your comments. Call the Marketing Department at 888-RAB-1000 or email: marketing@rabweb.com

WPLED52 Cool



All results are according to IESNA LM-79-2008: Approved Method for the Electrical and Photometric Testing of Solid-State Lighting. The U.S. Department of Energy (DOE) verifies product test data and results.

Visit www.lightingfacts.com for the Label Reference Guide.

Registration Number: WVMA-NVLZWC (3/29/2012)
Model Number: WPLED52 Upgraded 03/2012
Type: Outdoor wall pack

WPLED52 Cool

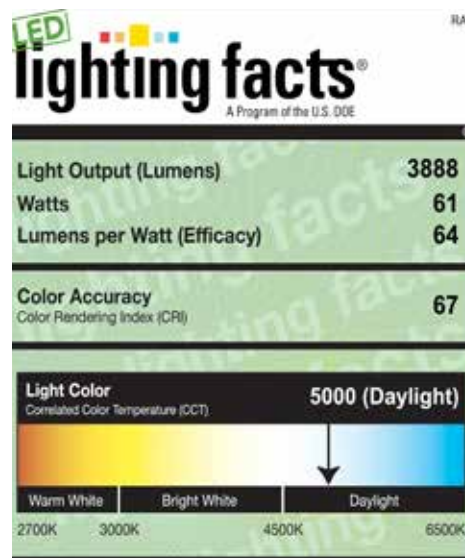

All results are according to IESNA LM-79-2008: Approved Method for the Electrical and Photometric Testing of Solid-State Lighting. The U.S. Department of Energy (DOE) verifies product test data and results.

Visit www.lightingfacts.com for the Label Reference Guide.

Registration Number: WVMA-6Z75NJ (3/29/2012)
Model Number: WPLED52 Upgraded 03/2012
Type: Outdoor wall pack

WPLED52 Cool



All results are according to IESNA LM-79-2008: Approved Method for the Electrical and Photometric Testing of Solid-State Lighting. The U.S. Department of Energy (DOE) verifies product test data and results.

Visit www.lightingfacts.com for the Label Reference Guide.

Registration Number: WVMA-7C2THS (3/29/2012)
Model Number: WPLED52 Upgraded 03/2012
Type: Outdoor wall pack

WPLED52N Neutral



All results are according to IESNA LM-79-2008: Approved Method for the Electrical and Photometric Testing of Solid-State Lighting. The U.S. Department of Energy (DOE) verifies product test data and results.

Visit www.lightingfacts.com for the Label Reference Guide.

Registration Number: WVMA-2LAJVE (5/3/2012)
Model Number: WPLED52N upgraded 4/2012
Type: Outdoor wall pack

WPLED52N Neutral

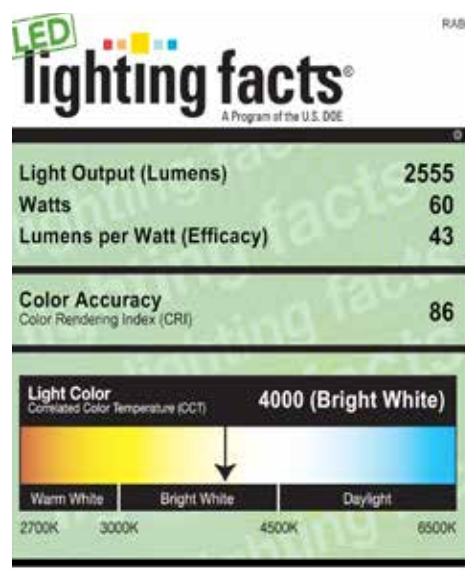

All results are according to IESNA LM-79-2008: Approved Method for the Electrical and Photometric Testing of Solid-State Lighting. The U.S. Department of Energy (DOE) verifies product test data and results.

Visit www.lightingfacts.com for the Label Reference Guide.

Registration Number: WVMA-QTG3GS (5/3/2012)
Model Number: WPLED52N upgraded 4/2012
Type: Outdoor wall pack

WPLED52N Neutral

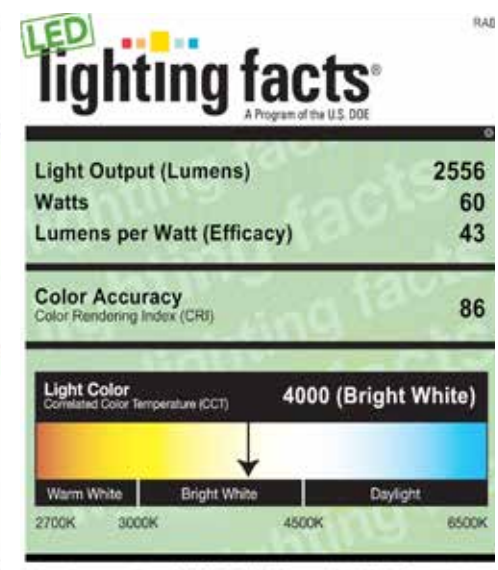

All results are according to IESNA LM-79-2008: Approved Method for the Electrical and Photometric Testing of Solid-State Lighting. The U.S. Department of Energy (DOE) verifies product test data and results.

Visit www.lightingfacts.com for the Label Reference Guide.

Registration Number: WVMA-8668FD (5/3/2012)
Model Number: WPLED52N Upgraded 4/2012
Type: Outdoor wall pack